

Features

- Dual N-Channel MOSFET
- Low On-Resistance
- Very Low Gate Threshold Voltage
- Low Input Capacitance
- Fast Switching Speed
- Low Input/Output Leakage
- Ultra-Small Surface Mount Package
- **Lead Free By Design/RoHS Compliant (Note 2)**
- **“Green” Device (Note 3)**



SOT-363

Mechanical Data

- Case: SOT-363
- Case Material: Molded Plastic, "Green" Molding Compound. UL Flammability Classification Rating 94V-0
- Moisture Sensitivity: Level 1 per J-STD-020C
- Terminal Connections: See Diagram
- Terminals: Finish — Matte Tin annealed over Alloy 42 leadframe. Solderable per MIL-STD-202, Method 208
- Marking Information: See Page 4
- Ordering & Date Code Information: See Page 4
- Weight: 0.006 grams (approximate)

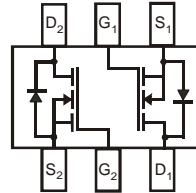
 TOP VIEW
Internal Schematic

Maximum Ratings @ $T_A = 25^\circ\text{C}$ unless otherwise specified

Characteristic	Symbol	Value	Units
Drain-Source Voltage	V_{DSS}	50	V
Drain-Gate Voltage $R_{GS} \leq 1.0M\Omega$	V_{DGR}	50	V
Gate-Source Voltage	V_{GSS}	± 20 ± 40	V
Drain Current (Note 1)	I_D	280	mA
Drain Current (Note 1)	I_{DM}	1.5	A

Thermal Characteristics @ $T_A = 25^\circ\text{C}$ unless otherwise specified

Characteristic	Symbol	Value	Units
Total Power Dissipation (Note 1)	P_d	200	mW
Thermal Resistance, Junction to Ambient (Note 1)	$R_{\theta JA}$	833	$^\circ\text{C}/\text{W}$
Operating and Storage Temperature Range	T_j, T_{STG}	-55 to +150	$^\circ\text{C}$

Electrical Characteristics @ $T_A = 25^\circ\text{C}$ unless otherwise specified

Characteristic	Symbol	Min	Typ	Max	Unit	Test Condition
OFF CHARACTERISTICS (Note 4)						
Drain-Source Breakdown Voltage	BV_{DSS}	50	—	—	V	$V_{GS} = 0V, I_D = 10\mu\text{A}$
Zero Gate Voltage Drain Current	I_{DSS}	—	—	0.1 500	μA	$V_{DS} = 50V, V_{GS} = 0V$ @ $T_C = 125^\circ\text{C}$
Gate-Body Leakage	I_{GSS}	—	—	± 20	nA	$V_{GS} = \pm 20V, V_{DS} = 0V$
ON CHARACTERISTICS (Note 4)						
Gate Threshold Voltage	$V_{GS(th)}$	0.49	—	1.2	V	$V_{DS} = V_{GS}, I_D = 250\mu\text{A}$
Static Drain-Source On-Resistance	$R_{DS(ON)}$	—	1.6 2.2	3 4	Ω	$V_{GS} = 2.7V, I_D = 0.2A,$ $V_{GS} = 1.8V, I_D = 50mA$
On-State Drain Current	$I_{D(ON)}$	0.5	1.0	—	A	$V_{GS} = 10V, V_{DS} = 7.5V$
Forward Transconductance	$ Y_{fs} $	200	—	—	mS	$V_{DS} = 10V, I_D = 0.2A$
Source-Drain Diode Forward Voltage	V_{SD}	0.5	—	1.4	V	$V_{GS} = 0V, I_S = 115mA$
DYNAMIC CHARACTERISTICS						
Input Capacitance	C_{iss}	—	—	50	pF	$V_{DS} = 25V, V_{GS} = 0V$ $f = 1.0MHz$
Output Capacitance	C_{oss}	—	—	25	pF	
Reverse Transfer Capacitance	C_{rss}	—	—	5.0	pF	

- Notes:
1. Device mounted on FR-4 PCB, 1 inch x 0.85 inch x 0.062 inch; pad layout as shown on Diodes Inc. suggested pad layout document AP02001, which can be found on our website at <http://www.diodes.com/datasheets/ap02001.pdf>.
 2. No purposefully added lead.
 3. Diodes Inc.'s "Green" policy can be found on our website at http://www.diodes.com/products/lead_free/index.php.
 4. Short duration pulse test used to minimize self-heating effect.

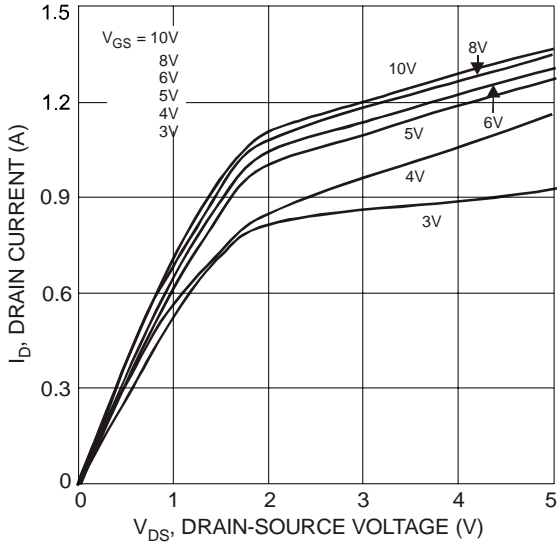

Fig. 1 Typical Output Characteristics

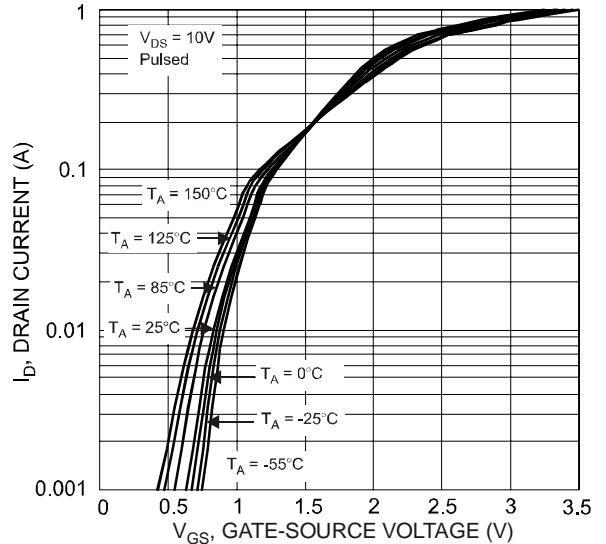

Fig. 2 Typical Transfer Characteristics

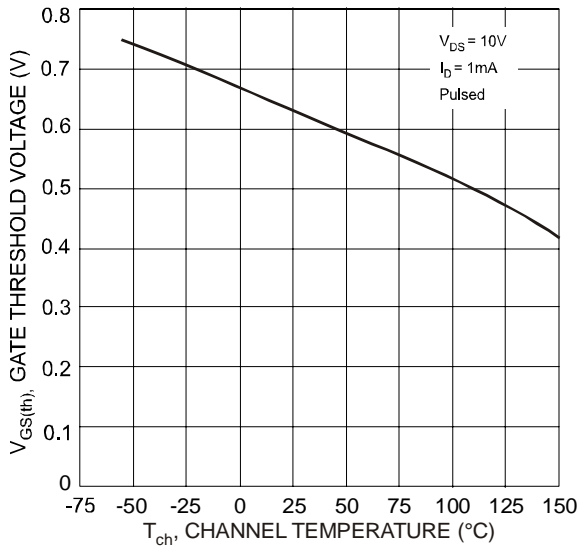

Fig. 3 Gate Threshold Voltage vs. Channel Temperature

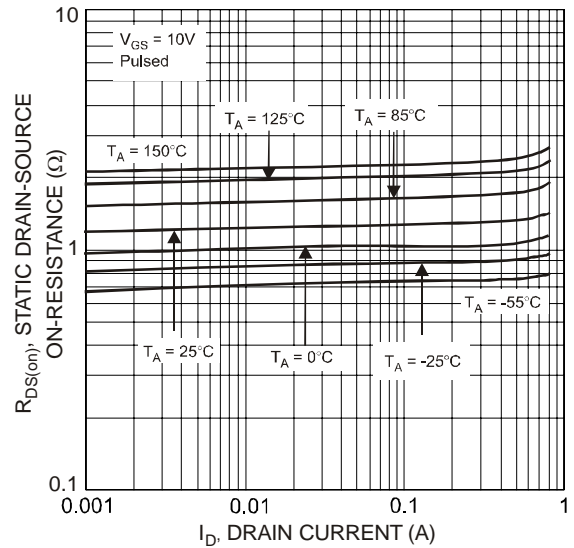

Fig. 4 Static Drain-Source On-Resistance vs. Drain Current

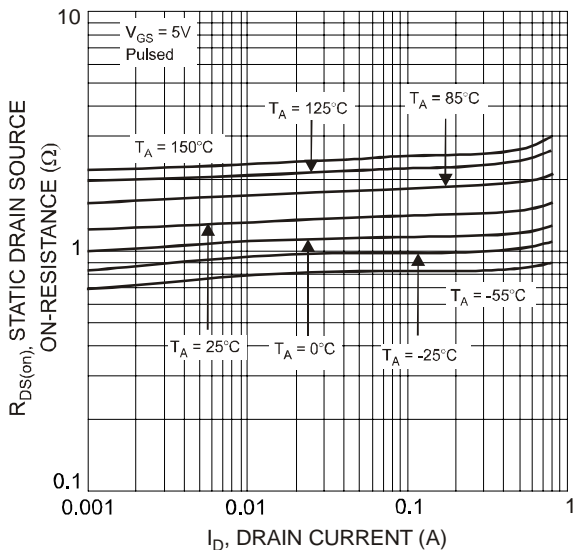

Fig. 5 Static Drain-Source On-Resistance vs. Drain Current

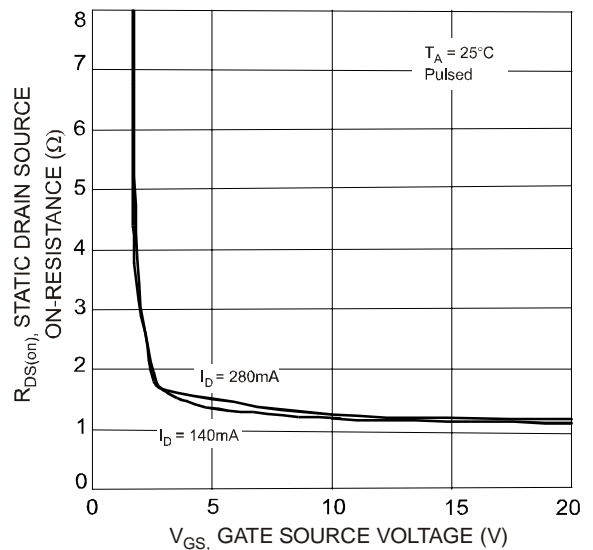

Fig. 6 Static Drain-Source On-Resistance vs. Gate-Source Voltage

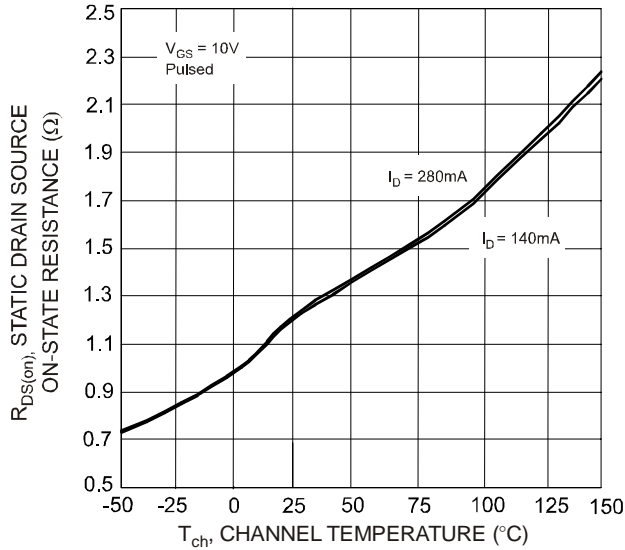

Fig. 7 Static Drain-Source On-State Resistance vs. Channel Temperature

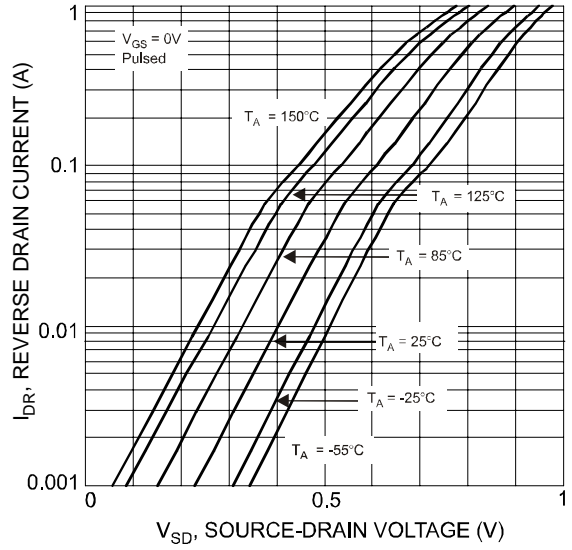

Fig. 8 Reverse Drain Current vs. Source-Drain Voltage

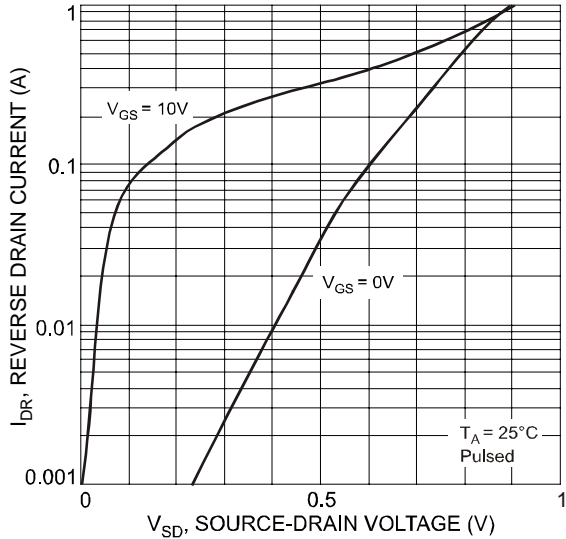

Fig. 9 Reverse Drain Current vs. Source-Drain Voltage

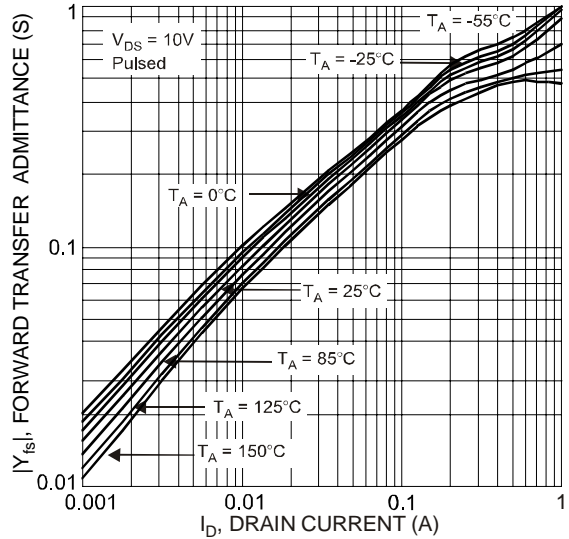

Fig. 10 Forward Transfer Admittance vs. Drain Current

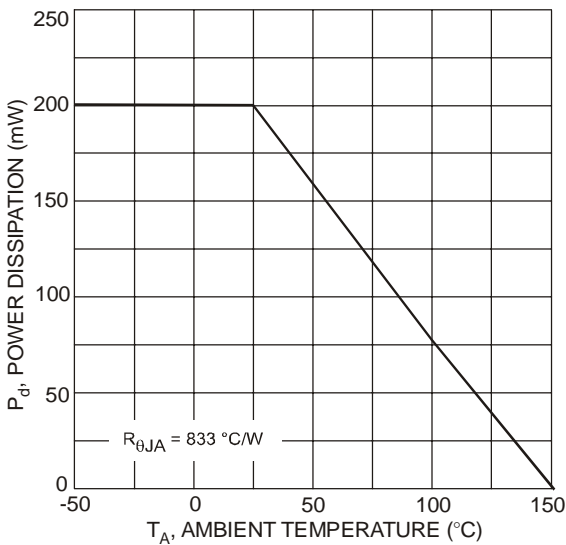

Fig. 11 Derating Curve - Total

Ordering Information (Note 5)

Part Number DMN5L06DW-7	Case SOT-363	Packaging 3000/Tape & Reel
-----------------------------------	------------------------	--------------------------------------

Notes: 5. For packaging details, go to our website at <http://www.diodes.com/datasheets/ap02007.pdf>.

Marking Information

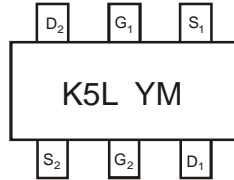

K5L = DMN5L06DW Product Type Marking Code (See Note 6)
 YM = Date Code Marking
 Y = Year ex: S = 2005
 M = Month ex: 9 = September

Notes: 6. Package is non-polarized. Parts may be on reel in orientation illustrated, 180° rotated, or mixed (both ways).

Date Code Key

Year	2005	2006	2007	2008	2009	2010	2011	2012
Code	S	T	U	V	W	X	Y	Z

Month	Jan	Feb	Mar	Apr	May	Jun	Jul	Aug	Sep	Oct	Nov	Dec
Code	1	2	3	4	5	6	7	8	9	O	N	D

Package Outline Dimensions

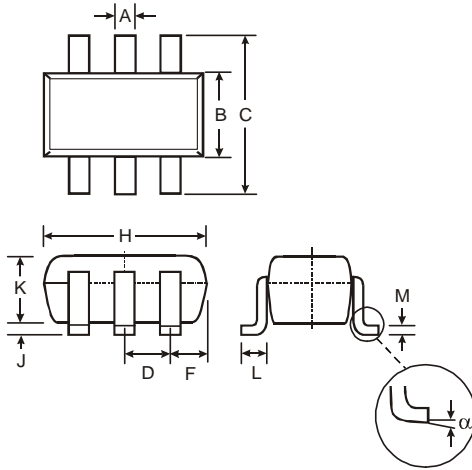

SOT-363		
Dim	Min	Max
A	0.10	0.30
B	1.15	1.35
C	2.00	2.20
D	0.65 Nominal	
F	0.30	0.40
H	1.80	2.20
J	—	0.10
K	0.90	1.00
L	0.25	0.40
M	0.10	0.25
α	0°	8°

All Dimensions in mm

Suggested Pad Layout

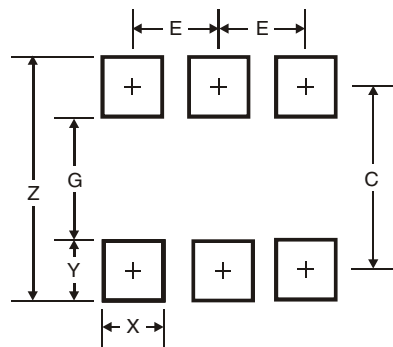

Dimensions	Value (in mm)
Z	2.5
G	1.3
X	0.42
Y	0.6
C	1.9
E	0.65

IMPORTANT NOTICE

Diodes Incorporated and its subsidiaries reserve the right to make modifications, enhancements, improvements, corrections or other changes without further notice to any product herein. Diodes Incorporated does not assume any liability arising out of the application or use of any product described herein; neither does it convey any license under its patent rights, nor the rights of others. The user of products in such applications shall assume all risks of such use and will agree to hold Diodes Incorporated and all the companies whose products are represented on our website, harmless against all damages.

LIFE SUPPORT

Diodes Incorporated products are not authorized for use as critical components in life support devices or systems without the expressed written approval of the President of Diodes Incorporated.